



 **HIGHFIELD** 2024

#DARETOEXPLORE



#DARETOEXPLORE WITH HIGHFIELD...

Highfield's state-of-the-art production facility is located in Weihai, China. Under European management, Highfield Boats has a rigging facility in the USA with support offices in Michigan and the European head office based in France.

With around 47,000 boats delivered globally since the brand's beginning in 2011, Highfield Boats is now the world's number one in the RIB tender sector and a global player in the 5 metres + sector. Performance and strength have always been at Highfield's core. The brand has focussed on these two key values above anything else. Highfield's hulls are dry-riding, very seaworthy and always over-built.

Their reputation for durability is now world-renowned. The heavy-duty approach to design and build allows both leisure and commercial owners to have the confidence needed to go that extra mile and to tackle conditions avoided by many others. As such, Highfield has been chosen time and again as the support boat of choice for prestigious events worldwide, with fleets up to 50 strong. From Vendee Globe to the Invictus Games, Pan Am Games, Extreme Sailing Series, ORC Championships, TP52 & The Route Du Rhum.

Sustainability is also a huge part of Highfield's DNA. All of the hulls and structures are built in aluminium, which is infinitely recyclable. In addition, Highfield powder coat in an enclosed area to ensure that their footprint remains low from the beginning of the manufacturing process through to the end of each product's life. With now over 48 distributor countries and a worldwide dealer network, Highfield owners can be confident any support they need will always be on hand.



CONTENTS

Brand Timeline	4-7
Ultralite Range	8-11
Classic Range Overview	12-13
Classic 260 & 290	14-15
Classic 310 & 340	16-17
Classic 360 & 380	18-19
Classic Console Options	20-21
Classic 420 & 460	22-23
Sport Range Overview	24-25
Sport 300, 330 & 360	26-27
Sport 390 - 460	28-29
Sport 520	30-31
Sport 560	32-33
Sport 600	34-35
Sport 660	36-37
Sport 700	38-39
Sport 760	40-41
Sport 800	42-43
Sport 900	44-45
Patrol Range Overview	46-47
Patrol 420 & 460	48-49
Patrol 500	50-51
Patrol 540	52-53
Patrol 600	54-55
Patrol 660	56-57
Patrol 700	58-59
Patrol 760	60-61
Patrol 860	62-63

Brand created with an Australian design and expertise, French/Chinese ownership. First boat show in La Rochelle.

Distributor group grows, first Distributor meeting takes place in Weihai

Highfield Boats enters into an alliance with Honda Marine throughout Key EU markets

Highfield enters the smallest vessels into the 1100 Nautical Mile "Round Ireland Challenge"

Highfield Supports Pan Am games in Toronto

Highfield Boats supplies 50 security RIBs to the Vendee Globe Organisation for the start and finish of VG 2016

Highfield enters into partnership with OC Sport and supplies a fleet to The Extreme Sailing Series

Highfield supplies the support fleet for TP52 racing fleet & ORC World Championships in Croatia



2011

'12

'13

'13

'15

'16

'16

'17

Highfield supplies support fleet for the Invictus Games

Highfield supplies 50 vessels to OC Sport for the start of Route Du Rhum in St Malo, France

Highfield takes direct control of its United States operation

Highfield Partners with Alex Thomson Racing and supports Hugo Boss through the IMOCA Globe series campaign

Highfield Once again supplies the 50 boat support and safety fleet for Vendee Globe

Highfield launches the Sport range

Highfield takes direct control of its Australia operation

Highfield Supplies once again 50 vessels for the security of Route Du Rhum and partners with OC Sport

Highfield releases new electric tender range in partnership with ePropulsion

'18

'18

'18

'19

'20

'20

'21

'22

'23



ULTRALITE



THE Ultralite Range are single deck dinghies, created always keeping weight in mind. Their light weight make them a real alternative for those who may have chosen a soft bottom tender in the past but would prefer a hard hull for its performance. Ultralite tenders are roomy and strong, yet light and easy to transport.

These little boats can be launched and recovered by a single man and are easy to be transported on a roof rack. The Ultralite's are made of 2.5mm thick powder coated marine grade aluminium for the hull and 1100 Dtex fabric for the inflatable tube.

BECAUSE WEIGHT DOES MATTER

2024 COLOUR SCHEMES



B-G



DG-G



LG-W



W-W

ULTRALITE RANGE

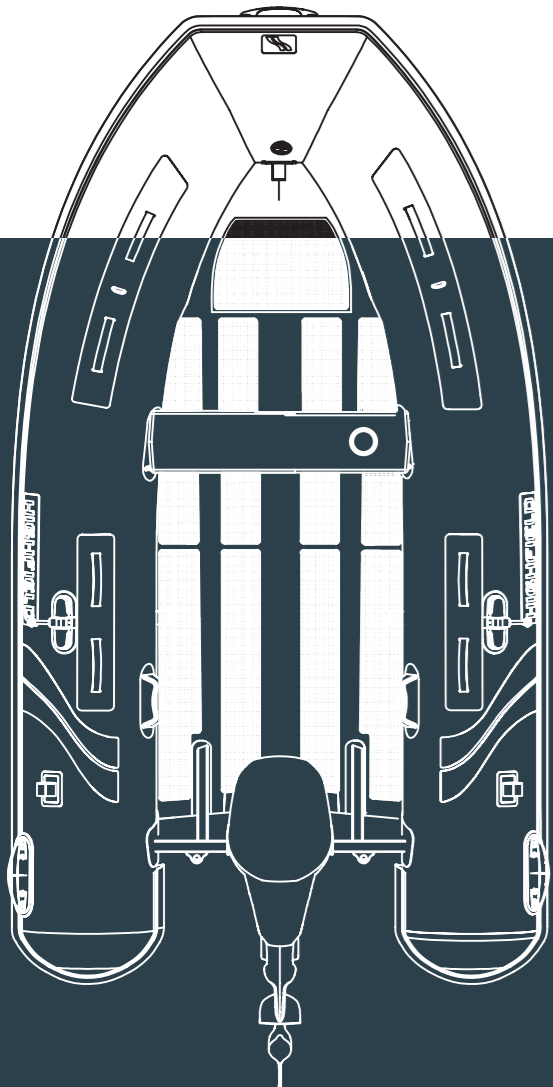

	VL220		VL240		VL260		VL290		VL310		VL340	
OVERALL LENGTH	220cm	7'3"	240cm	7'10"	260cm	8'6"	290cm	9'6"	313cm	10'3"	337cm	11'1"
INTERNAL LENGTH	145cm	4'9"	164cm	5'4"	184cm	6'	214cm	7'	224cm	7'4"	243cm	8'
OVERALL WIDTH	152cm	5'	154cm	5'1"	154cm	5'1"	154cm	5'1"	172cm	5'8"	172cm	5'8"
INTERNAL WIDTH	75cm	2'6"	78cm	2'7"	77cm	2'6"	77cm	2'6"	79cm	2'7"	79cm	2'7"
DEADRISE	10.5°		10.5°		10.5°		15°		15°		15°	
TUBE DIAMETER *	38cm	15"	38cm	15"	38cm	15"	38cm	15"	44cm	17"	44cm	17"
NUMBER OF AIR CHAMBERS	3		3		3		3		3		3	
MAXIMUM LOAD	296kg	653lbs	296kg	653lbs	340kg	750lbs	375kg	827lbs	585kg	1290lbs	663kg	1462lbs
MAXIMUM PEOPLE	3		3		3+1		4		5		5+1	
BOAT WEIGHT **	30kg	65lbs	33kg	72lbs	35kg	77lbs	39kg	86lbs	50kg	110lbs	53kg	117lbs
MAXIMUM POWER	5hp		6hp		6hp		10hp		15hp		20hp	
ENGINE SHAFT	S		S		S		S		S		S	
DESIGN CATEGORY	C		C		C		C		C		C	

* larger tube diameters available ** boat only

STANDARD FEATURES

- ORCA® Hypalon or PVC tube
- Welded seams (PVC)
- Flush mount non-return valves
- High tensile chromated & powder coated aluminum hull
- Removable seat
- Lifting points and towing eyes
- Tow bridle points
- Anti-slip deck
- Light weight rubbing strake
- Full length keel guard
- Under seat bag
- Highfield dry bag
- Foot pump, oars, repair kit
- EVA

OPTIONAL EXTRAS

- Extra seat
- Boat cover



CLASSIC



THE Classic Range offers extra levels of comfort in this double deck hulled dinghy that will keep your feet dry. The hulls of the Classics are built of 2.5mm thick powder coated marine grade aluminium. The tubes are made of 1100 dtex coated fabric.

The high quality finish and luxury look belies the fact that this range of tenders has been designed to work hard. A durable aluminium hull coupled with full length keel guards make these ideal for those beach-hopping days with friends and family.

The optional FCT console or GT console options allow forward steering control for increased comfort and greater ease of navigation.

These options offer a more luxurious tender experience whilst still keeping the weight down.

The large weight savings achieved compared to equivalent GRP tenders means you'll enjoy impressive performance with smaller engines, all combined with excellent payload capacities

2023 also welcomes the arrival of the Classic E Range, modified for and powered by ePropulsion. This addition means the Classic range really does offer a tender for everyone.

2024 COLOUR SCHEMES

OPEN TENDER

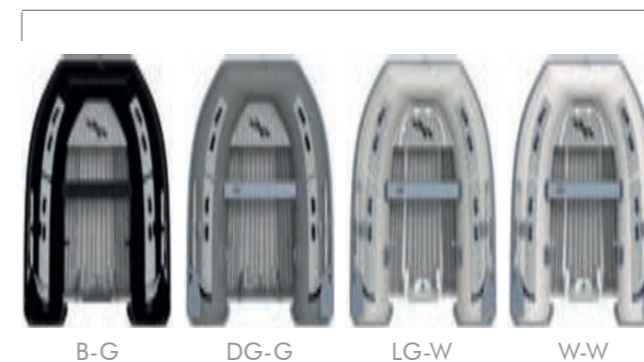

GT CONSOLE OPTION



FCT CONSOLE OPTION



CLASSIC 260 & 290

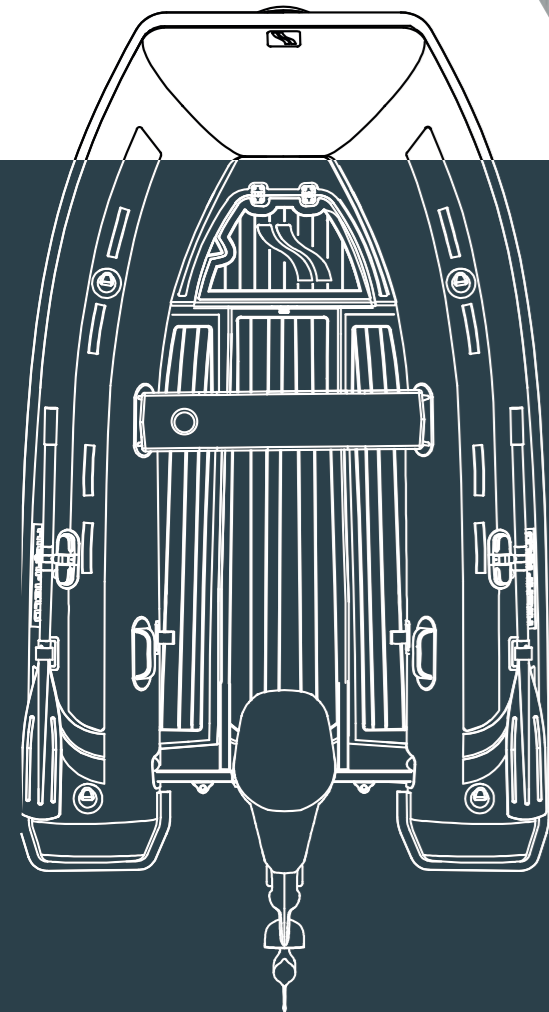

STANDARD FEATURES

- ORCA® Hypalon or PVC tube
- Welded seams (PVC)
- Flush mount non-return valves
- High tensile chromated & powder coated aluminum hull
- Bow locker (Fit 24L fuel tank)
- Integrated transom supports
- Removable seat
- Bow cushion
- Lifting points and towing eyes
- Tow bridle points
- Brushed foam teak finish deck
- Heavy duty rubbing strake
- Full length keel guard
- Tank strap kit
- Under seat bag
- Highfield dry bag
- Foot pump, oars, repair kit

OPTIONAL EXTRAS

- FRP Bow Step
- Molded bow cleat
- Boat cover
- Classic Jockey Console (CL290)

THE COMPACT MODELS CAN CARRY 4 PEOPLE, MAKING THEM IDEAL FOR SHORT TRIPS. AGILE & STRONG OFFERING A 480KG PAYLOAD.

	CL260		CL290	
OVERALL LENGTH	260cm	8'6"	290cm	9'6"
INTERNAL LENGTH	176cm	5'9"	206cm	6'9"
OVERALL WIDTH	170cm	5'7"	170cm	5'7"
INTERNAL WIDTH	79cm	2'7"	79cm	2'7"
DEADRISE	10.5°		15°	
TUBE DIAMETER	44cm	17"	44cm	17"
NUMBER OF AIR CHAMBERS	3		3	
MAXIMUM LOAD	360kg	794lbs	480kg	1058lbs
MAXIMUM PEOPLE	3+1		4	
BOAT WEIGHT*	54kg	119lbs	59kg	130lbs
MAXIMUM POWER	15hp		20hp	
ENGINE SHAFT	S		S	
DESIGN CATEGORY	C		C	

* boat only



CLASSIC 310 & 340

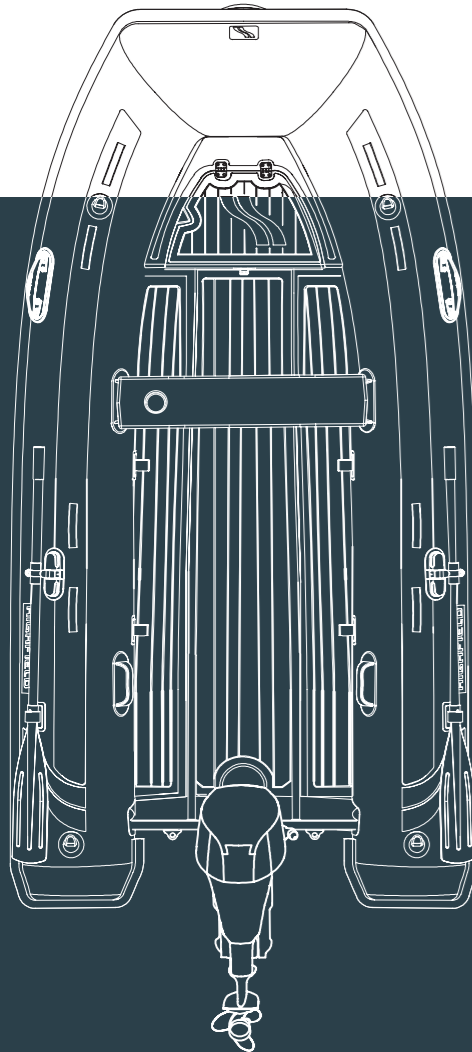

STANDARD FEATURES

- ORCA® Hypalon or PVC tube
- Welded seams (PVC)
- Flush mount non-return valves
- High tensile chromated & powder coated aluminum hull
- Bow locker (Fit 24L fuel tank)
- Integrated transom supports
- Removable seat
- Bow cushion
- Lifting points and towing eyes
- Tow bridle points
- Brushed foam teak finish deck
- Heavy duty rubbing strake
- Full length keel guard
- Tank strap kit
- Under seat bag
- Highfield dry bag
- Foot pump, oars, repair kit

OPTIONAL EXTRAS

- Console Options*
- FRP/Nylon Bow Step
- Molded bow cleat
- Boat cover

* see page 20

OUR EASY HANDLING 5 & 6 MAN MODELS ARE GREAT ALL-ROUNDERS. THE ALUMINIUM HULL FEATURES 3 LIFTING POINTS. THEY CAN BE FITTED WITH AN OPTIONAL CONSOLE TO MAKE IT EVEN EASIER RIDING. BOW LOCKER & FUEL TANK STORAGE AS STANDARD MAKE THIS A POPULAR CHOICE.

	L310		L340	
OVERALL LENGTH	310cm	10'2"	340cm	11'2"
INTERNAL LENGTH	226cm	7'5"	247cm	8'1"
OVERALL WIDTH	170cm	5'7"	170cm	5'7"
INTERNAL WIDTH	79cm	2'7"	79cm	2'7"
DEADRISE	15°		15°	
TUBE DIAMETER	44cm	17"	44cm	17"
NUMBER OF AIR CHAMBERS	3		3	
MAXIMUM LOAD	511kg	1127lbs	551kg	1215lbs
MAXIMUM PEOPLE	5		6	
BOAT WEIGHT**	62kg	137lbs	71kgs	157lbs
MAXIMUM POWER	20hp		25hp	
ENGINE SHAFT	S		S	
DESIGN CATEGORY	C		C	

** boat only



CLASSIC 360 & 380

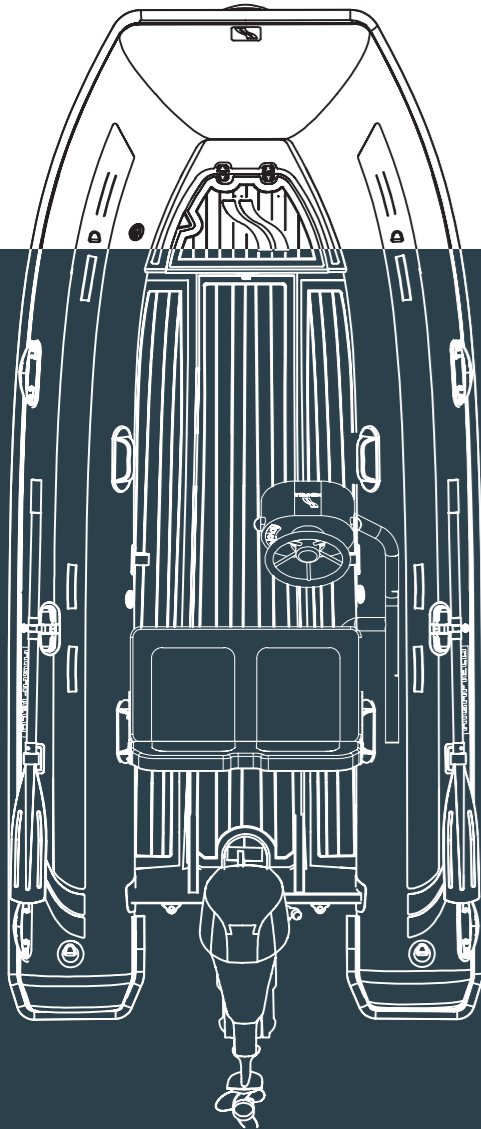

STANDARD FEATURES

- ORCA® Hypalon or PVC tube
- Welded seams (PVC)
- Flush mount non-return valves
- High tensile chromated & powder coated aluminum hull
- Bow locker (Fit 24L fuel tank)
- Integrated transom supports
- Removable seat
- Bow cushion
- Lifting points and towing eyes
- Tow bridle points
- Brushed foam teak finish deck
- Heavy duty rubbing strake
- Full length keel guard
- Tank strap kit
- Under seat bag
- Highfield dry bag
- Foot pump, oars, repair kit

OPTIONAL EXTRAS

- Console Options*
- FRP/Nylon Bow Step
- Molded bow cleat
- Boat cover

* see page 20

THESE ROOMY MODELS COMBINE AN IMPRESSIVE PAYLOAD WITH GREAT HANDLING. FRONT LOCKER & FUEL TANK STORAGE AS STANDARD. OPTIONAL CONSOLE. PERFECT FOR LONGER DISTANCES OR LARGER LOADS.

	L360		L380	
OVERALL LENGTH	360cm	11'10"	380cm	12'6"
INTERNAL LENGTH	267cm	8'9"	287cm	9'5"
OVERALL WIDTH	170cm	5'7"	170cm	5'7"
INTERNAL WIDTH	79cm	2'7"	79cm	2'7"
DEADRISE	15°		15°	
TUBE DIAMETER	44cm	17"	44cm	17"
NUMBER OF AIR CHAMBERS	3		3	
MAXIMUM LOAD	561kg	1237lbs	637kg	1404lbs
MAXIMUM PEOPLE	6		7	
BOAT WEIGHT**	75kg	165lbs	83kg	183lbs
MAXIMUM POWER	30hp		30hp	
ENGINE SHAFT	S		S	
DESIGN CATEGORY	C		C	

** boat only



PHOTO CREDIT: VOYAGES OF AGAPE

CONSOLE OPTIONS CL340 & UP



FCT CONSOLE

The FCT console package is a perfect addition to any Classic 310 up to Classic 380 model giving you an additional level of comfort and enjoyability for your day on the water. The rear bench seat with high backrest and closed cell foam cushions which won't hold water, are perfect for a comfortable day exploring. The console helm is an open style design giving you unprecedented legroom in a boat of its size while a carbon dash with LED switches and branded steering wheel add a dash of style. An electrical package including led flush mounted switch panel, navigation lights and bilge pump are all standard.

WEIGHT: 36kg / 80lbs CAPACITY: 100l / 3.5 cu ft



GT CONSOLE

The NEW "Grand Tour" GT version console option combines lightweight and performance of the Classic line but with more comfort and styling from the luxury Sport boats for a perfect combination of reliability and styling. The Classic GT is available for CL340 and up, turning the Classic into an easy handling runabout, perfect for having fun when you've anchored for lunch.

CONSOLE WEIGHT: 25.5kg / 56lbs FOLDING SEAT WEIGHT: 20kg / 45lbs

CLASSIC 420 & 460

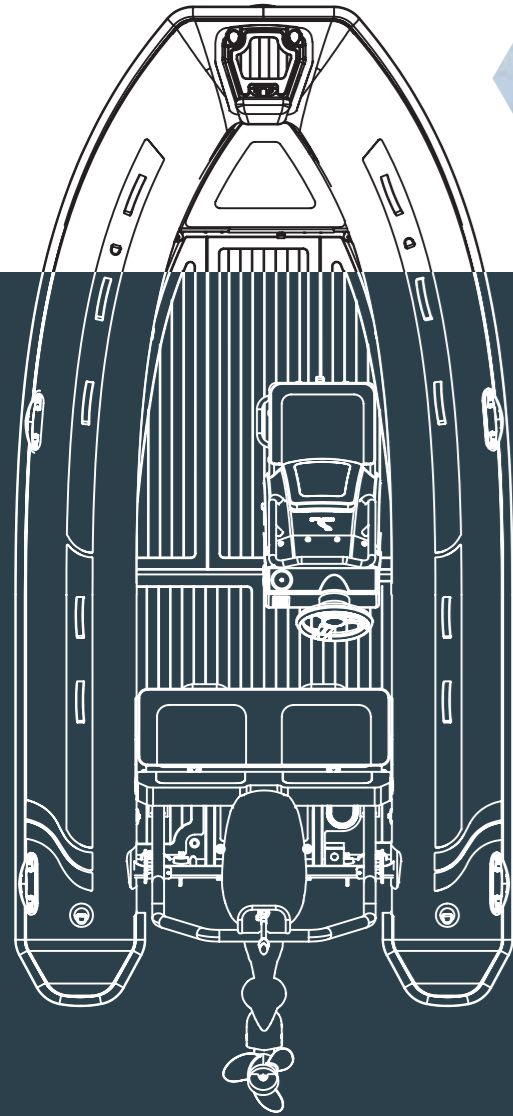
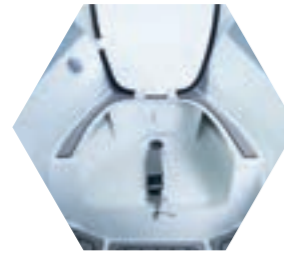

STANDARD FEATURES

- ORCA® Hypalon or PVC tube
- Welded seams (PVC)
- Flush mount non-return valves
- High tensile chromated & powder-coated aluminum hull
- Self-draining deck
- Bow locker
- Console & Seat
- Carbon dash for console
- FRP Bow Step & bow cushion
- Integrated transom supports
- Lifting points and towing eyes
- Tow bridle points
- Brushed foam teak finish deck
- Heavy duty rubbing strake
- Full length keel guard
- Tank strap kit
- Highfield dry bag
- Foot pump, oars, repair kit
- Electrical packs for boat & console
- Carbon dash for console

OPTIONAL EXTRAS

- Roll bar
- Boat cover

LIGHTWEIGHT AND CAPABLE, THIS BOAT CAN BE BUILT TO SUIT YOUR TENDER REQUIREMENTS. THE LARGEST CLASSIC MODELS ARE VERY CAPABLE RIBS WITH EXCELLENT LAYOUT OPTIONS AND WILL SUIT MULTIPLE SITUATIONS. THE PERFECT BEACH HOPPER, GREAT TENDER OR EXCELLENT FAMILY DAY BOAT.

	CL420		CL460	
OVERALL LENGTH	421cm	13'10"	459cm	15'1"
INTERNAL LENGTH	317cm	10'5"	353cm	11'7"
OVERALL WIDTH	210cm	6'11"	211cm	6'11"
INTERNAL WIDTH	105cm	3'5"	105cm	3'5"
DEADRISE	20°		20°	
TUBE DIAMETER	47cm	19"	47cm	19"
NUMBER OF AIR CHAMBERS	4		5	
MAXIMUM LOAD	823kg	1814lbs	944kg	2081lbs
MAXIMUM PEOPLE	8		9	
BOAT WEIGHT*	204kg	450lbs	238kg	525lbs
MAXIMUM POWER	60hp		80hp	
ENGINE SHAFT	L		L	
FUEL TANK (LITRES)	40l		40l	
DESIGN CATEGORY	C		C	

* boat only





THE

SPORT range of high quality boats offers a choice from 3 metres up to 9 metres and combines all of our hull design expertise with an interior that you demand. Nothing has been sacrificed in the design of this range. Top quality materials are the hallmark of what we do and we have not compromised.

Hull deadrise angles ranging from 20 degrees on the 3 metre going through to a huge 26 degrees on the 600 and up will give you assurance in the toughest conditions. The additions such as EVA teak throughout, superb diamond stitched upholstery, fridges, showers and bathing platforms on our larger models will allow you to enjoy each day to the maximum.

With the impermeable qualities of our aluminium hulls there's no need to worry about gelcoat chips, or putting the boat on a beach or trailer. All Highfield Sport RIBs are easy to tow, launch and recover due to their light weight and integrated davit lifting eyes. Your Sport will not delaminate or absorb water over time, retaining the same agile performance in 10 years time as the day you collected it.

The Highfield Boats Sport range offers the very best solution for your requirement. Low weight garage tender or runabout, through to an offshore mile crunching cruiser.

2024 COLOUR SCHEMES

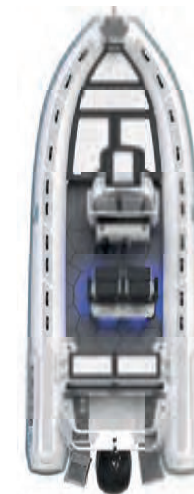

CODE

B-B-B

B-B-DB

B-W-C

DG-G-MB

I-B-B

LG-W-DB

LG-W-WB

W-W-WB

SPORT 300-360

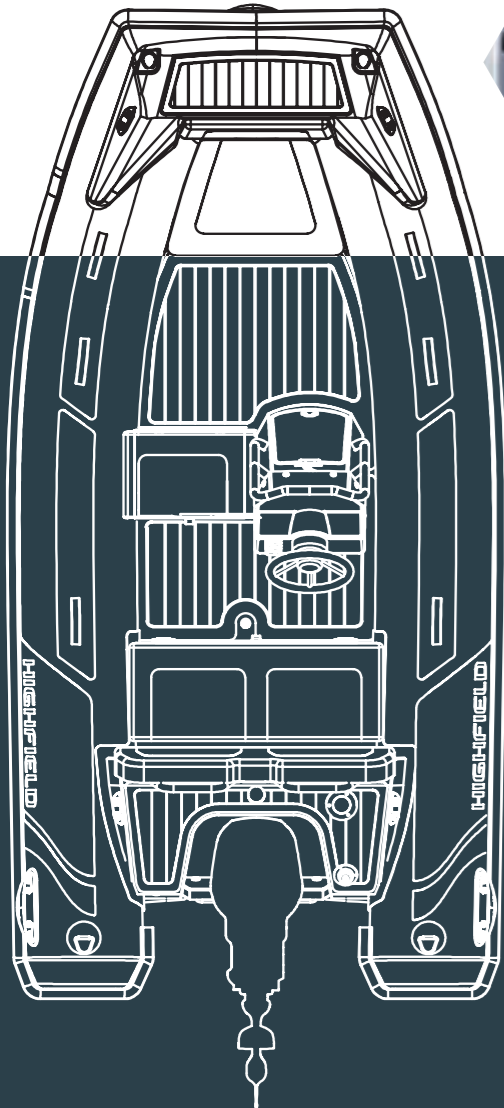
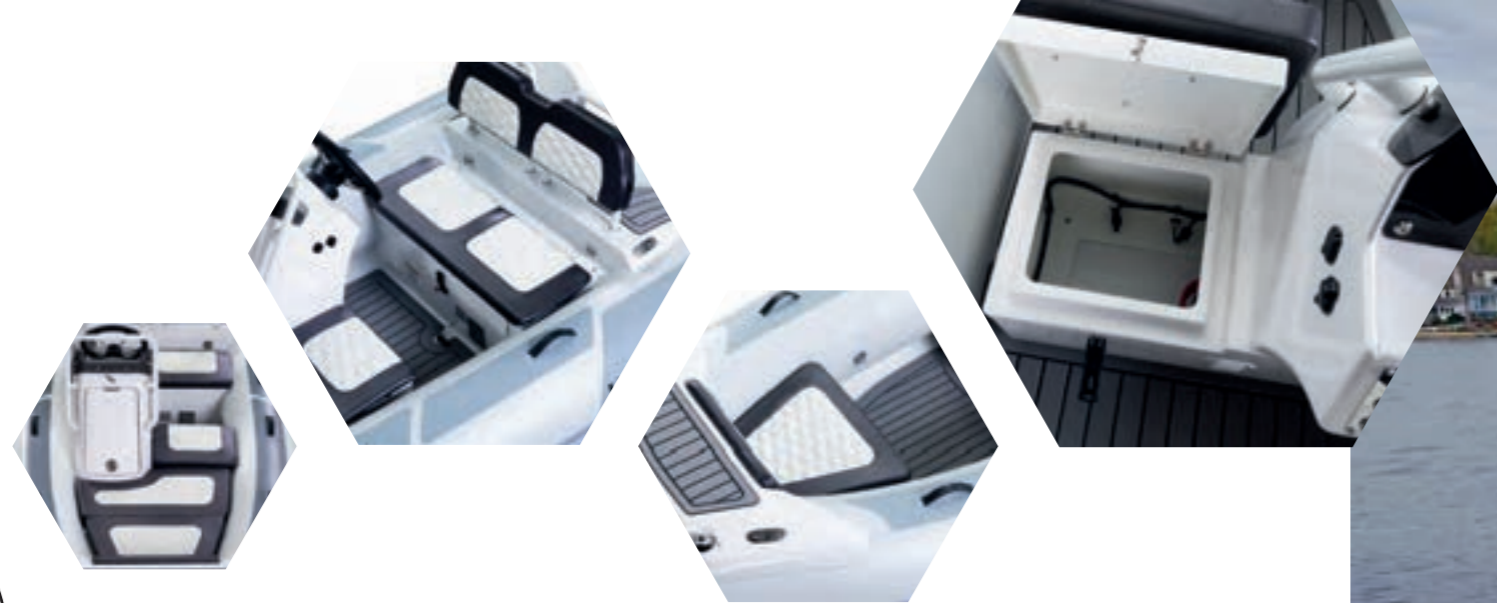

STANDARD FEATURES

- ORCA® Hypalon or PVC tube
- Welded seams (PVC)
- Flush mount non-return valves
- High tensile chromated & powder coated aluminum hull
- Integrated rear seat with cushion
- Integrated transom supports
- Lifting points and towing eyes
- Brushed foam teak finish deck
- Heavy duty rubbing strake
- Keel guard
- Highfield dry bag
- Foot pump, oars, repair kit
- Electrical pack for boat & console
- Carbon dash for console
- Steering wheel

OPTIONAL EXTRAS

- Boat cover
- Mechanical steering system
- Sundeck (330 up)
- Tow post (330 up)

TRUE LIGHTWEIGHT LUXURY. OUR SMALLEST SPORT MODELS MAKE THE IDEAL TENDER, SMALL ENOUGH TO SIT ON THE BACK OF MOST CRUISERS. SMALL AND NIMBLE, BUT WITH ENOUGH ROM TO CARRY EVERYTHING YOU NEED FOR A DAY ON THE WATER.

	SP300		SP330		SP360	
OVERALL LENGTH	300cm	9'10"	336cm	11'	362cm	11'11"
INTERNAL LENGTH	180cm	5'11"	204cm	6'8"	236cm	7'9"
OVERALL WIDTH	183cm	6'	182cm	6'	184cm	6'
INTERNAL WIDTH	84cm	2'9"	90cm	2'11"	92cm	3'
DEADRISE	20°		20°		20°	
TUBE DIAMETER	43cm	17"	43cm	17"	43cm	17"
NUMBER OF AIR CHAMBERS	3		3		3	
MAXIMUM LOAD	464kg	1023lbs	549kg	1211lbs	634kg	1398lbs
MAXIMUM PEOPLE	4		5		6	
BOAT WEIGHT*	175kg	385lbs	199kg	439lbs	215kg	473lbs
MAXIMUM POWER	30hp		30hp		40hp	
ENGINE SHAFT	L		L		L	
FUEL TANK (LITRES)	N/A		30l		30l	
DESIGN CATEGORY	C		C		C	

* boat & console only



SPORT 390-460

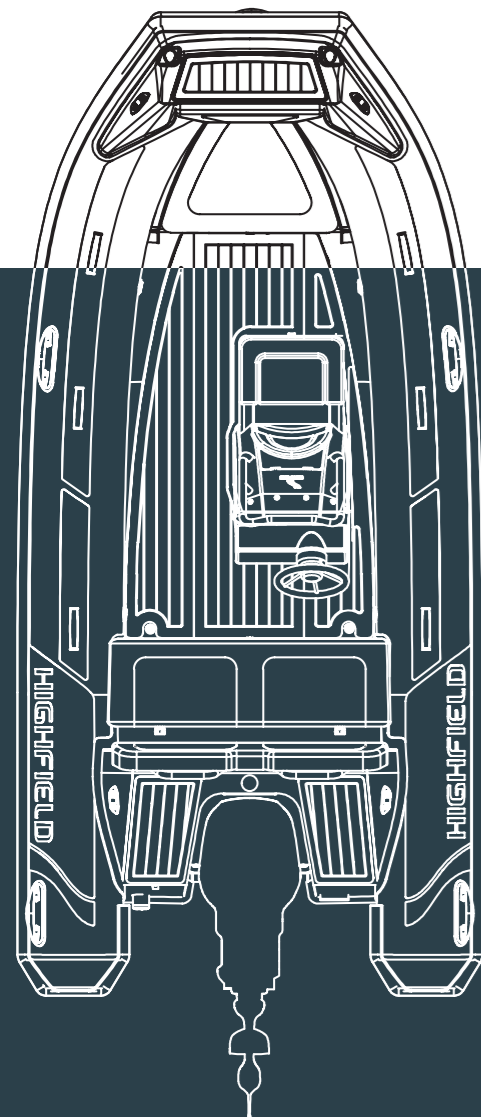

STANDARD FEATURES

- ORCA® Hypalon or PVC tube
- Welded seams (PVC)
- Flush mount non-return valves
- High tensile chromated & powder coated aluminum hull
- Self-draining deck (SP420 up)
- Integrated rear seat with cushion
- Integrated transom supports
- Lifting points and towing eyes
- Brushed foam teak finish deck
- Heavy duty rubbing strake
- Keel guard
- Highfield dry bag
- Foot pump & repair kit
- Electrical pack for boat & console
- Carbon dash for console
- Steering wheel

OPTIONAL EXTRAS

- Boat cover
- Sundeck
- Tow post
- Roll bar
- Forward arch

THESE MODELS MAKE A PERFECT FAMILY DAYBOAT OR TENDER FOR A LARGER MOTOR CRUISER OR CATAMARAN. AMPLE STORAGE & OPTIONAL SUNDECK AND TOW POST.

	SP390		SP420		SP460	
OVERALL LENGTH	390cm	12'10"	424cm	13'11"	460cm	15'1"
INTERNAL LENGTH	250cm	8'2"	272cm	8'11"	291cm	9'7"
OVERALL WIDTH	192cm	6'4"	205cm	6'9"	209cm	6'10"
INTERNAL WIDTH	92cm	3'	108cm	3'7"	108cm	3'7"
DEADRISE	20°		20°		20°	
TUBE DIAMETER	47cm	19"	47cm	19"	47cm	19"
NUMBER OF AIR CHAMBERS	3		4		5	
MAXIMUM LOAD	716kg	1579lbs	791kg	1744lbs	912kg	2011lbs
MAXIMUM PEOPLE	7		8		9	
BOAT WEIGHT*	226kg	497lbs	309kg	681lbs	332kg	732lbs
MAXIMUM POWER	60hp		70hp		90hp	
ENGINE SHAFT	L		L		L	
FUEL TANK (LITRES)	30l		55l		55l	
DESIGN CATEGORY	C		C		C	

* boat & console only



THESE MODELS MAKE A PERFECT FAMILY DAYBOAT OR TENDER FOR A LARGER MOTOR CRUISER OR CATAMARAN. AMPLE STORAGE & OPTIONAL SUNDECK AND TOW POST.

SPORT 520

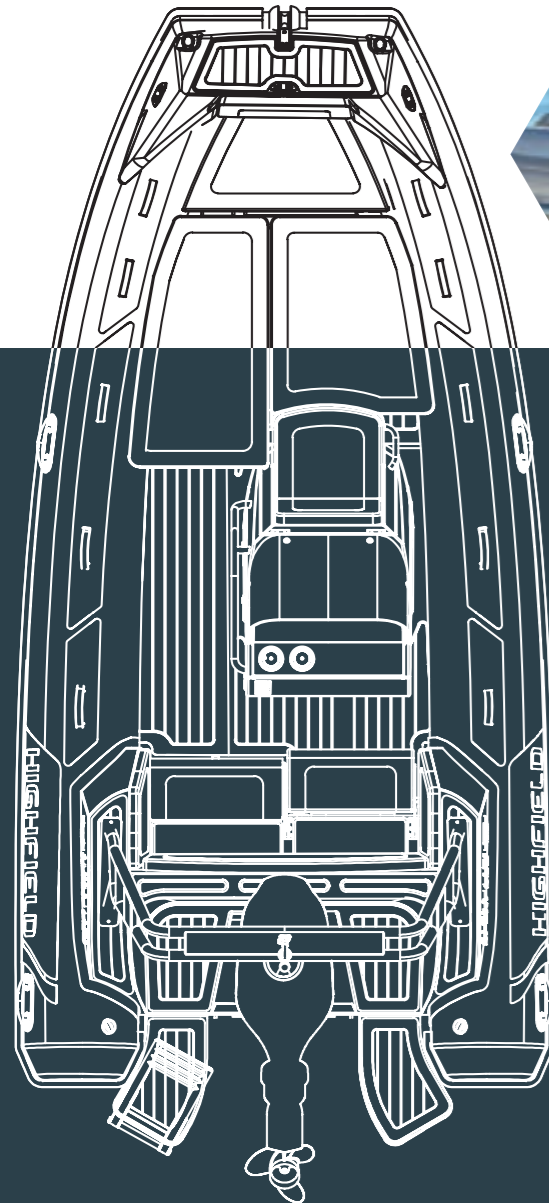

STANDARD FEATURES

- ORCA® Hypalon or PVC tube
- Welded seams (PVC)
- Flush mount non-return valves
- High tensile chromated & powder coated aluminum hull
- Self-draining deck
- Integrated rear seat with cushion
- Integrated transom supports
- Lifting points and towing eyes
- Brushed foam teak finish deck
- Heavy duty rubbing strake
- Keel guard
- Highfield dry bag
- Foot pump & repair kit
- Electrical pack for boat & console
- Carbon dash for console
- Platform with ladder
- Steering wheel

OPTIONAL EXTRAS

- Boat cover
- Sundeck
- Tow post
- Roll bar
- Forward arch

EXCELLENT INTERNAL STORAGE OPTIONS AND GREAT ERGONOMICS MAKE THESE MODELS A JOY TO DRIVE. A 105 LITRE FUEL TANK (SP520) GIVES YOU GREAT RANGE BETWEEN FUEL STOPS & THE TOW POST/ROLL BAR ALLOWS YOU TO PULL A WAKEBOARD WITH EASE.

OVERALL LENGTH	523cm	17'2"
INTERNAL LENGTH	343cm	11'3"
OVERALL WIDTH	246cm	8'1"
INTERNAL WIDTH	130cm	4'3"
DEADRISE	24°	
TUBE DIAMETER	52cm	20"
NUMBER OF AIR CHAMBERS	6	
MAXIMUM LOAD	1058kg	2332lbs
MAXIMUM PEOPLE	10	
BOAT WEIGHT*	516kg	1136lbs
MAXIMUM POWER	100hp	
ENGINE SHAFT	L	
FUEL TANK (LITRES)	105l	

* boat & console only



SPORT 560

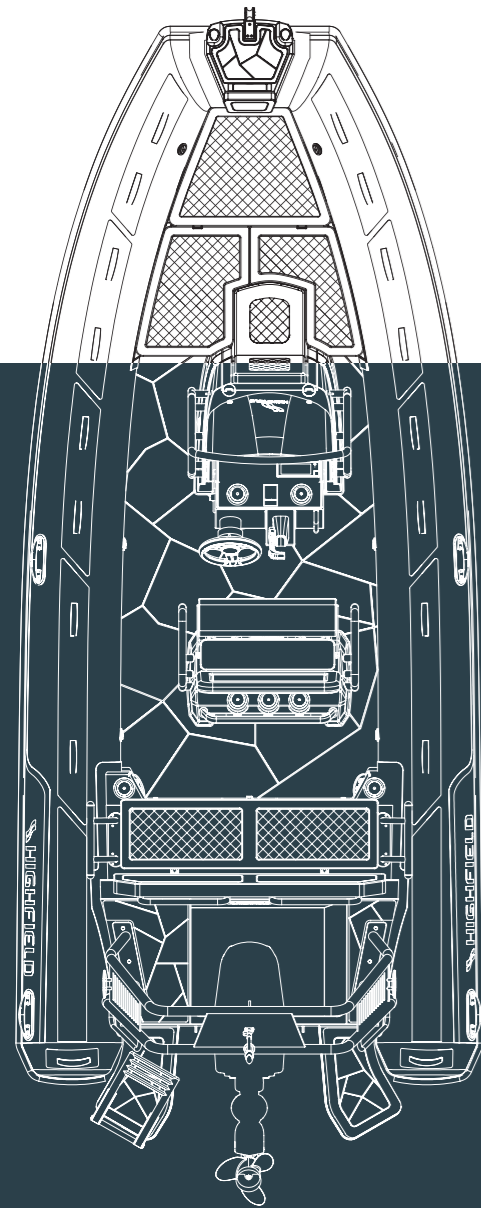

STANDARD FEATURES

- ORCA® Hypalon or PVC tube
- Welded seams (PVC)
- Hydraulic steering system & steering wheel
- Flush mount non-return valves
- High tensile chromated & powder coated aluminum hull
- Self-draining deck
- Integrated rear seat with cushion
- Integrated transom supports
- Lifting points and towing eyes
- Brushed foam teak finish deck
- Heavy duty rubbing strake
- Keel guard
- Highfield dry bag
- Foot pump & repair kit
- Electrical pack for boat & console
- Carbon dash for console
- Platform with ladder
- Roll bar
- Cooler bag
- Sundeck

OPTIONAL EXTRAS

- Boat cover
- Sunshade
- T-Top

ONE OF THE MOST VERSATILE MEDIUM SIZED RIBS IN ITS CLASS. IN ADDITION TO IT'S ACCLAIMED HULL DESIGN, SWIM PLATFORMS PORT AND STARBOARD & OPTIONAL TOW POST MAKE THIS AN EXCELLENT WATER SPORTS PLATFORM FOR THE WHOLE FAMILY.

OVERALL LENGTH	586cm	19'3"
INTERNAL LENGTH	396cm	13'1"
OVERALL WIDTH	250cm	8'3"
INTERNAL WIDTH	131cm	4'3"
DEADRISE	24°	
TUBE DIAMETER *	52cm	20"
NUMBER OF AIR CHAMBERS	6	
MAXIMUM LOAD	1375kg	3031lbs
MAXIMUM PEOPLE	12	
BOAT WEIGHT **	682kg	1502lbs
MAXIMUM POWER	115hp	
ENGINE SHAFT	XL	
FUEL TANK	105l	
DESIGN CATEGORY	C	

*smaller tube diameter available ** boat, console & standard seating only



SPORT 600

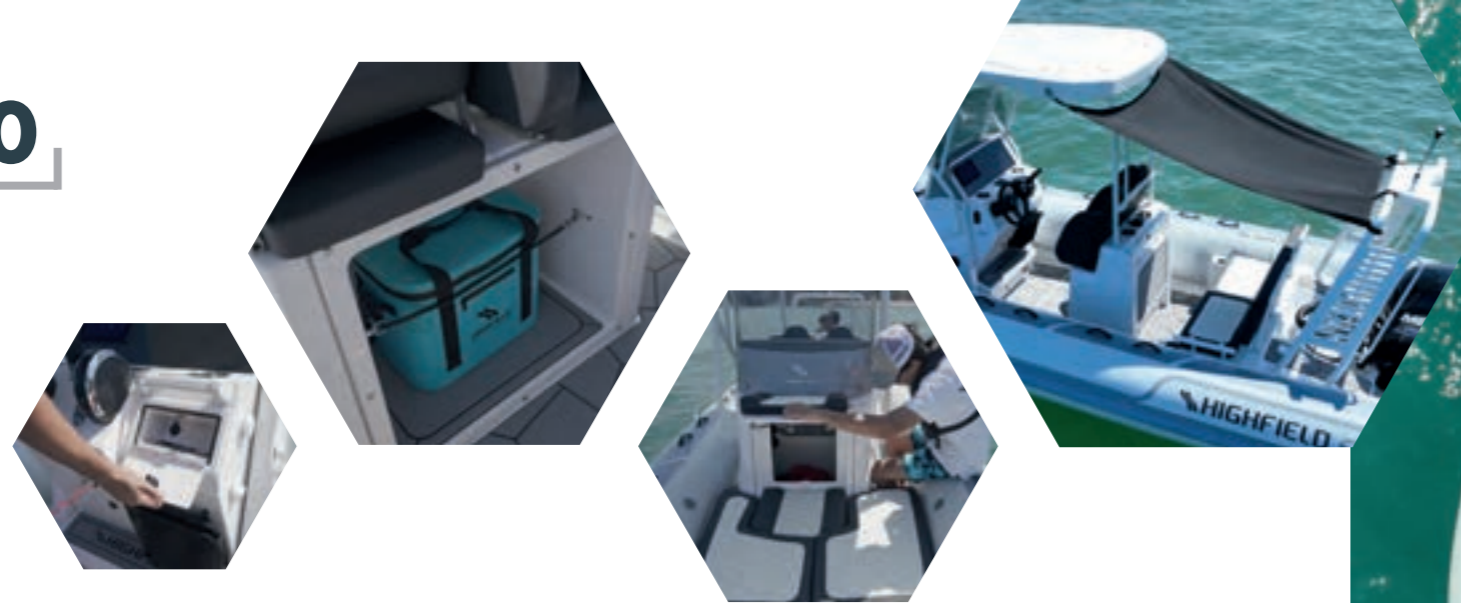
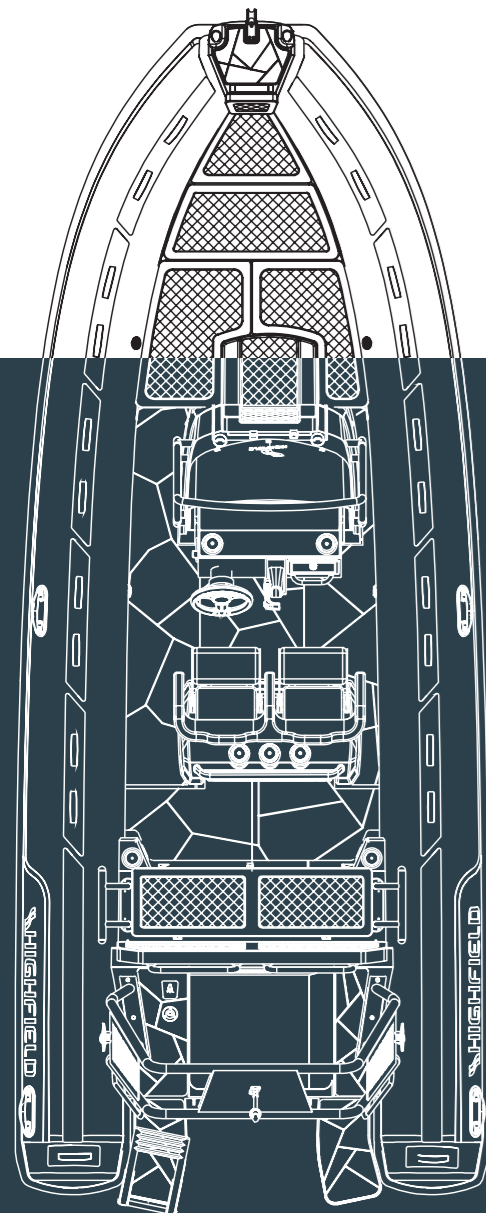

STANDARD FEATURES

- ORCA® Hypalon or PVC tube
- Welded seams (PVC)
- Flush mount non-return valves
- High tensile chromated & powder coated aluminum hull
- Hydraulic steering system & steering wheel
- Self-draining deck
- Integrated rear seat with cushion
- Integrated transom supports
- Lifting points and towing eyes
- Brushed foam teak finish deck
- Heavy duty rubbing strake
- Keel guard
- Highfield dry bag
- Foot pump & repair kit
- Electrical pack for boat & console
- Carbon dash for console
- Platform with ladder
- Sundeck - Roll bar - Shower kit
- Cooler bag

OPTIONAL EXTRAS

- T-Top
- Sunshade
- Boat Cover

THIS POCKET, FAMILY OFFSHORE RIB OFFERS EXCEPTIONAL VALUE AND GREAT CAPABILITY. SHOWER KIT AS STANDARD IS A GREAT ADDITION FOR SEA SWIMS!

OVERALL LENGTH	626cm	20'6"
INTERNAL LENGTH	445cm	14'6"
OVERALL WIDTH	249cm	8'2"
INTERNAL WIDTH	129cm	4'2"
DEADRISE	26°	
TUBE DIAMETER *	56-40cm	22-16"
NUMBER OF AIR CHAMBERS	6	
MAXIMUM LOAD	1580kg	3483lbs
MAXIMUM PEOPLE	14	
BOAT WEIGHT **	630kg	1389kg
MAXIMUM POWER	150hp	
ENGINE SHAFT	XL	
FUEL TANK	140l	
DESIGN CATEGORY	C	

*smaller tube diameter available ** boat, console, roll-bar & standard seating only



SPORT 660

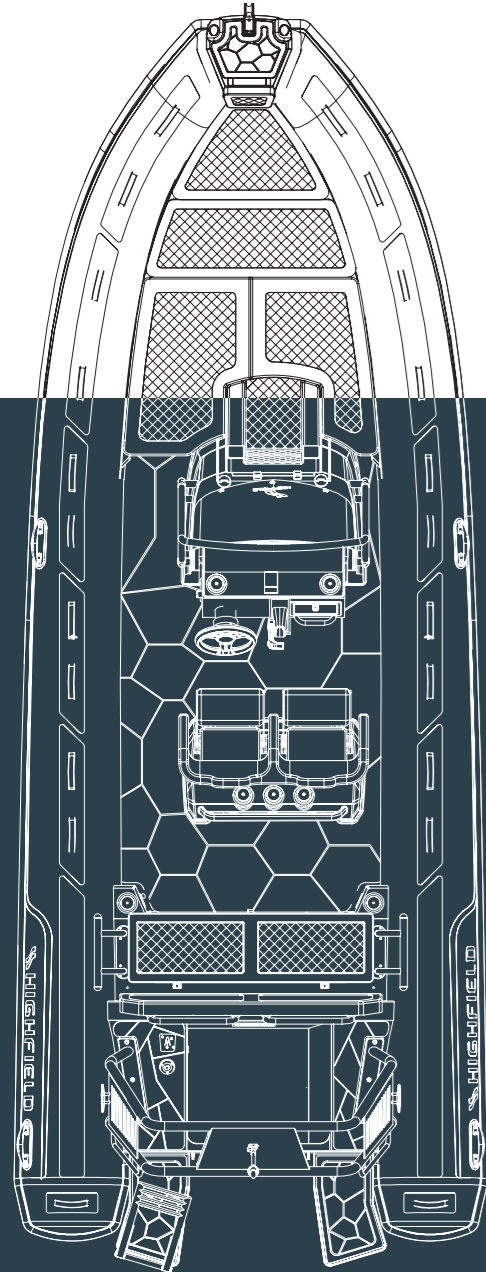

STANDARD FEATURES

- ORCA® Hypalon or PVC tube
- Welded seams (PVC)
- Flush mount non-return valves
- High tensile chromated & powder coated aluminum hull
- Hydraulic steering system & steering wheel
- Self-draining deck
- Integrated rear seat with cushion
- Integrated transom supports
- Lifting points and towing eyes
- Brushed foam teak finish deck
- Heavy duty rubbing strake
- Keel guard
- Highfield dry bag
- Foot pump & repair kit
- Electrical pack for boat & console
- Carbon dash for console
- Platform with ladder
- Sundeck - Roll bar
- Shower kit - Cooler bag

OPTIONAL EXTRAS

- Sunshade
- T-top
- Boat Cover

OUR MID-SIZED FAMILY RIB WITH A SUPER DEEP-V HULL WILL ALLOW YOU TO DARE TO EXPLORE FURTHER ALONG WITH IT'S 140L FUEL TANK.

OVERALL LENGTH	665cm	21'10"
INTERNAL LENGTH	475cm	15'7"
OVERALL WIDTH	256cm	8'5"
INTERNAL WIDTH	132cm	4'3"
DEADRISE	26°	
TUBE DIAMETER	56-40cm	22-16"
NUMBER OF AIR CHAMBERS	6	
MAXIMUM LOAD	1630kg	3594lbs
MAXIMUM PEOPLE	14	
BOAT WEIGHT*	781kg	1721lbs
MAXIMUM POWER	200hp	
ENGINE SHAFT	XL	
FUEL TANK	140l	
DESIGN CATEGORY	C	

* boat, console, roll-bar & standard seating only



SPORT 700

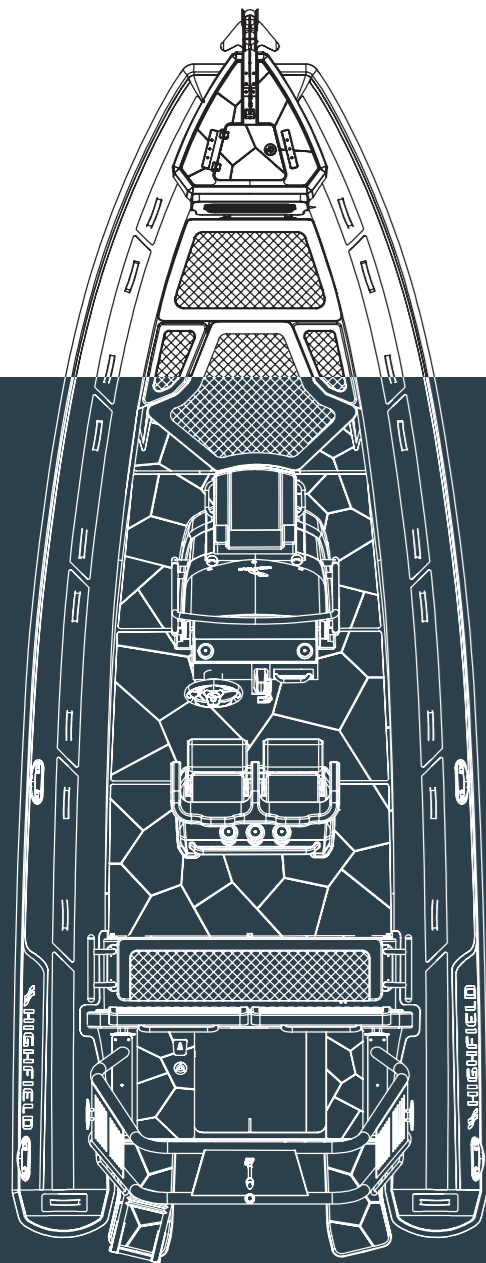

STANDARD FEATURES

- ORCA® Hypalon
- Flush mount non-return valves
- High tensile chromated & powder coated aluminum hull
- Self-draining deck
- Hydraulic steering system & steering wheel
- Integrated rear seat with cushion
- Integrated transom supports
- Lifting points and towing eyes
- Brushed foam teak finish deck
- Heavy duty rubbing strake
- Keel guard
- Highfield dry bag
- Foot pump & repair kit
- Electrical pack for boat & console
- Carbon dash for console
- Platform with ladder
- Sundeck - Roll bar
- Shower kit
- Cooler bag

OPTIONAL EXTRAS

- Sunshade
- T-top - Windlass
- Boat Cover

THE SPORT 700 IS A BOAT AT HOME WHEN THE WEATHER GETS UP. THE 26 DEGREE DEADRISE HULL EATS THE CHOP AND KEEPS YOU AND YOUR FAMILY DRY AND SECURE IN ALL CONDITIONS.

OVERALL LENGTH	699cm	22'11"
INTERNAL LENGTH	478cm	15'8"
OVERALL WIDTH	293cm	9'7"
INTERNAL WIDTH	170cm	5'7"
DEADRISE	26°	
TUBE DIAMETER	58cm	23"
NUMBER OF AIR CHAMBERS	6	
MAXIMUM LOAD	1630kg	3594lbs
MAXIMUM PEOPLE	14	
BOAT WEIGHT*	1023kg	2255lbs
MAXIMUM POWER	250hp	
ENGINE SHAFT	XL	
FUEL TANK	285l	
DESIGN CATEGORY	C	

* boat, console, standard seating, sundeck & roll bar only



* LIMITED EDITION OF LES VOILES DE ST TROPEZ - SUBJECT TO AVAILABILITY

SPORT 760

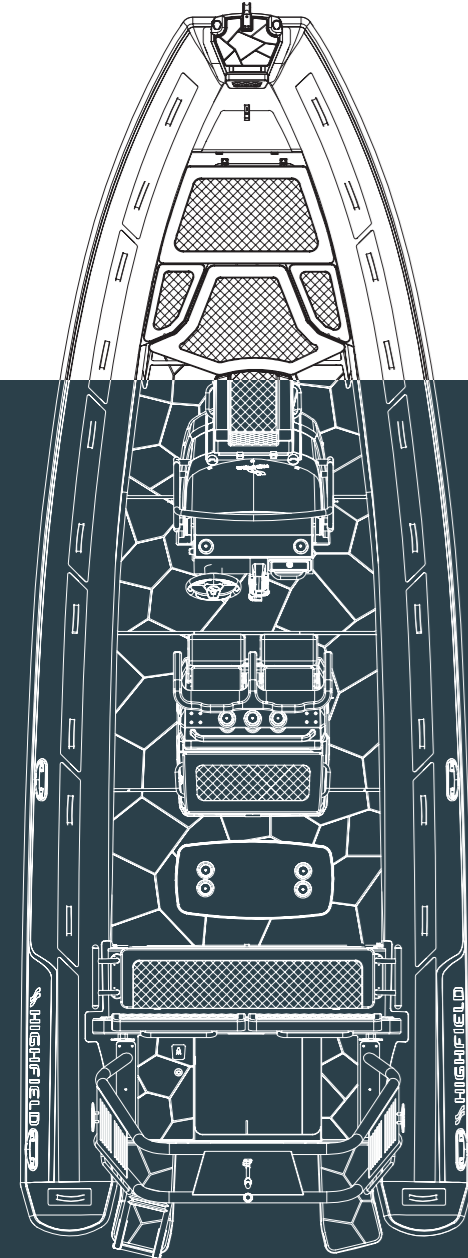

STANDARD FEATURES

- ORCA® Hypalon
- Flush mount non-return valves
- High tensile chromated & powder coated aluminum hull
- Self-draining deck
- Hydraulic steering system & steering wheel
- Integrated rear seat with cushion
- Integrated transom supports
- Lifting points and towing eyes
- Brushed foam teak finish deck
- Heavy duty rubbing strake
- Keel guard
- Highfield dry bag
- Foot pump & repair kit
- Electrical pack for boat & console
- Carbon dash for console
- Platform with ladder
- Sundeck
- Roll bar
- Shower kit
- Fridge - Table

OPTIONAL EXTRAS

- T-top - Boat Cover
- Sunshade - Windlass

FLAGSHIP SINGLE ENGINED FAMILY RIB WITH HUGE OFFSHORE CAPABILITY AND AN INCREDIBLY SPACIOUS FAMILY FRIENDLY LAYOUT. THE MASSIVE SUNDECK & REAR SEATING MAKE FOR A SOCIAL SPACE!

OVERALL LENGTH	777cm	25'6"
INTERNAL LENGTH	590cm	19'4"
OVERALL WIDTH	294cm	9'8"
INTERNAL WIDTH	169cm	5'7"
DEADRISE	26°	
TUBE DIAMETER	58cm	23"
NUMBER OF AIR CHAMBERS	6	
MAXIMUM LOAD	1820kg	4012lbs
MAXIMUM PEOPLE	16	
BOAT WEIGHT*	1108kg	2443lbs
MAXIMUM POWER	300hp	
ENGINE SHAFT	XL	
FUEL TANK	250l	
DESIGN CATEGORY	C	

* boat, console, standard seating, sundeck & roll bar only



SPORT 800

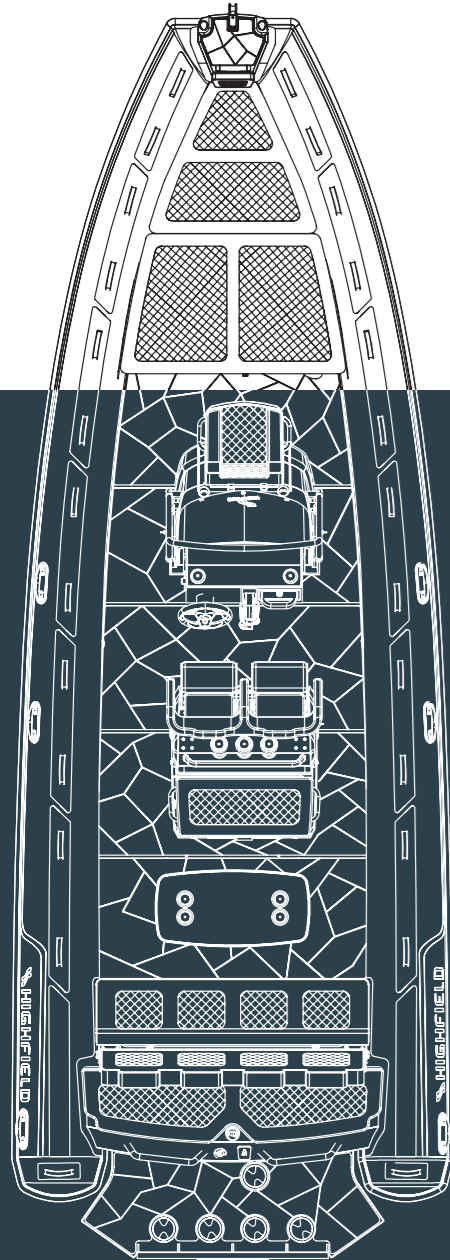
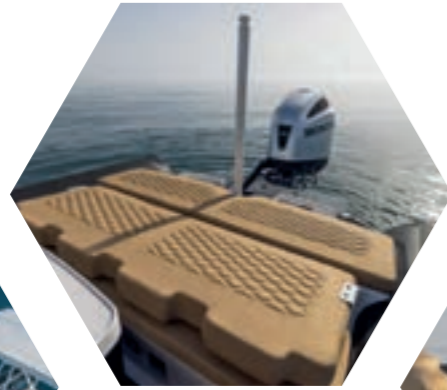

STANDARD FEATURES

- ORCA® Hypalon
- Flush mount non-return valves
- High tensile chromated & powder coated aluminum hull
- Self-draining deck
- Steering wheel
- Integrated rear seat with cushion
- Integrated transom supports
- Lifting points and towing eyes
- Brushed foam teak finish deck
- Heavy duty rubbing strake
- Keel guard
- Highfield dry bag
- Foot pump & repair kit
- Electrical pack for boat & console
- Carbon dash for console
- Platform with ladder
- Sundeck
- Shower kit
- Fridge - Table
- T-Top
- Tow post
- Windlass

OPTIONAL EXTRAS

- Sunshade
- Boat Cover

A NEW MODEL FOR 2024, THE SPORT 800 IS A FANTASTIC ADDITION TO THE LINEUP. FEATURING MULTIPLE SEATING CONFIGURATIONS, THERE'S ROOM FOR ALL OF YOUR FAMILY AND FRIENDS!

OVERALL LENGTH	812cm	26'8"
INTERNAL LENGTH	635cm	20'10"
OVERALL WIDTH	291cm	9'6"
INTERNAL WIDTH	169cm	5'6"
DEADRISE	26°	
TUBE DIAMETER	58cm	23"
NUMBER OF AIR CHAMBERS	6	
MAXIMUM LOAD	2025kg	4464lbs
MAXIMUM PEOPLE	15	
BOAT WEIGHT*	1120kg	2469lbs
MAXIMUM POWER	350hp/2*300hp	
ENGINE SHAFT	XL	
FUEL TANK	250l	
DESIGN CATEGORY	C	

* boat, console, standard seating, sundeck & roll bar only



SPORT 900

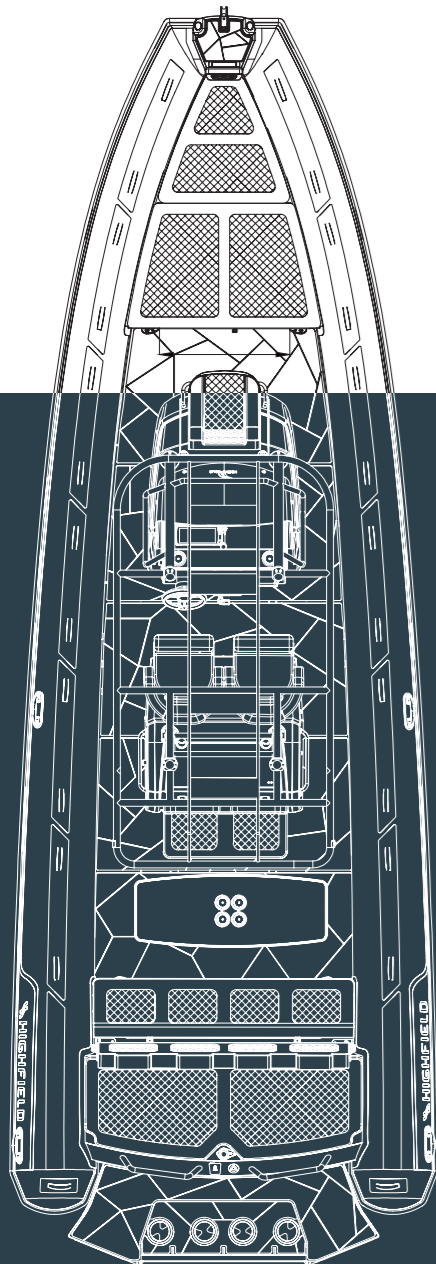

STANDARD FEATURES

- ORCA® Hypalon
- Flush mount non-return valves
- High tensile chromated & powder coated aluminum hull
- Self-draining deck
- Steering wheel
- Integrated rear seat with cushion
- Integrated transom supports
- Lifting points and towing eyes
- Brushed foam teak finish deck
- Heavy duty rubbing strake
- Keel guard
- Highfield dry bag
- Foot pump & repair kit
- Electrical pack for boat & console
- Carbon dash for console
- Platform with ladder
- Sundeck
- Shower kit
- Fridge - Table
- T-Top
- Tow post
- Windlass

OPTIONAL EXTRAS

- Sunshade
- Boat Cover

OUR LARGEST CRUISING RIB OFFERS MASSIVE INTERNAL SPACE, HUGE DISTANCE CAPABILITY AND THE OPTION FOR UP TO 600HP. A REAL HEADTURNER.

OVERALL LENGTH	912cm	29'11"
INTERNAL LENGTH	699cm	22'11"
OVERALL WIDTH	310cm	10'2"
INTERNAL WIDTH	184cm	6'
DEADRISE	26°	
TUBE DIAMETER	58cm	23"
NUMBER OF AIR CHAMBERS	6	
MAXIMUM LOAD	2656kg	5855lbs
MAXIMUM PEOPLE	19	
BOAT WEIGHT*	1780kg	3924lbs
MAXIMUM POWER	2 x 300hp	
ENGINE SHAFT	XL	
FUEL TANK	380l	
DESIGN CATEGORY	C or B	

* boat, console, standard seating, sundeck & roll bar only





THE

Patrol range of commercial quality RIBs are designed to work both excellently as a long distance family cruiser or a hardcore work boat. Built to withstand the toughest of conditions.

The hull is built from 5083 aluminium plates with 6 and 10mm stringers. With their super deep V, wide chines and large diameter tube, they offer high manoeuvrability, high safety and a soft dry ride even in the roughest conditions.

The range offers something for almost every requirement, from Sailing club support to Police and Rescue applications.

The Patrol boats carry large loads and plane quickly and easily with little horse-power. For charter boat and commercial operators, the modular set-up option means that we can build a layout that suits your needs. These boats are ideal pursuit craft or work boats and can be configured with different seating and console options.

With MCA rating & commercial coding available, the Patrol range is perfect for commercial chartering or working offshore too. When safety, toughness & reliability really matter, the Patrol range should be your first port of call.



2024 COLOUR SCHEMES

CODE



B-B-B



DG-G-DG



LG-W-DG



O-G-DG



R-B-B

PATROL 420 & 460

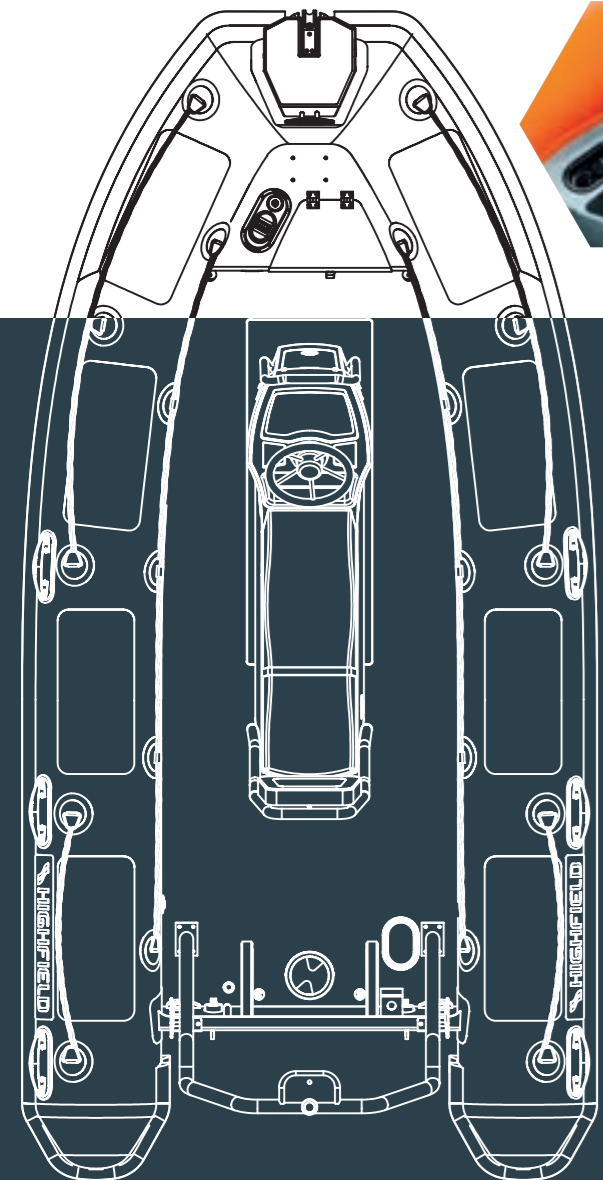

STANDARD FEATURES

- ORCA® Hypalon or PVC tube
Welded seams (PVC)
- Flush mount non-return valves
- High tensile chromated & powder coated aluminum hull
- Integrated transom supports
- Self-draining deck
- Steering wheel
- Integrated under-deck fuel tank
- Lifting points and towing eyes
- Tow bridle points
- Anti-slip deck
- Heavy duty rubbing strake
- Keel guard
- Highfield dry bag
- Foot pump, oars, repair kit
- Carbon dash
- Electrical pack for console
- Electrical pack for boat
- Transom ladder

OPTIONAL EXTRAS

- Console & seat options
- Rear tow post - Roll Bar
- Suspension seat with shock

THE PERFECT SMALL WORKBOAT, BUILT TO BE STRONG & AGILE. THE IDEAL CHOICE FOR SAILING CLUBS, HARBOURS OR EVEN AS SMALL RESCUE BOATS

	PA420		PA460	
OVERALL LENGTH	421cm	13'10"	459cm	15'1"
INTERNAL LENGTH	317cm	10'5"	353cm	11'7"
OVERALL WIDTH	210cm	6'11"	211cm	6'11"
INTERNAL WIDTH	105cm	3'5"	105cm	3'5"
DEADRISE	20°		20°	
TUBE DIAMETER	47cm	19"	47cm	19"
NUMBER OF AIR CHAMBERS	4		5	
MAXIMUM LOAD	885kg	1951lbs	1040kg	2293lbs
MAXIMUM PEOPLE	8		9	
BOAT WEIGHT*	252kg	556lbs	290kg	639lbs
MAXIMUM POWER	60hp		80hp	
ENGINE SHAFT	L		L	
FUEL TANK (LITRES)	55l		55l	

* boat, console & roll-bar only

PATROL 500

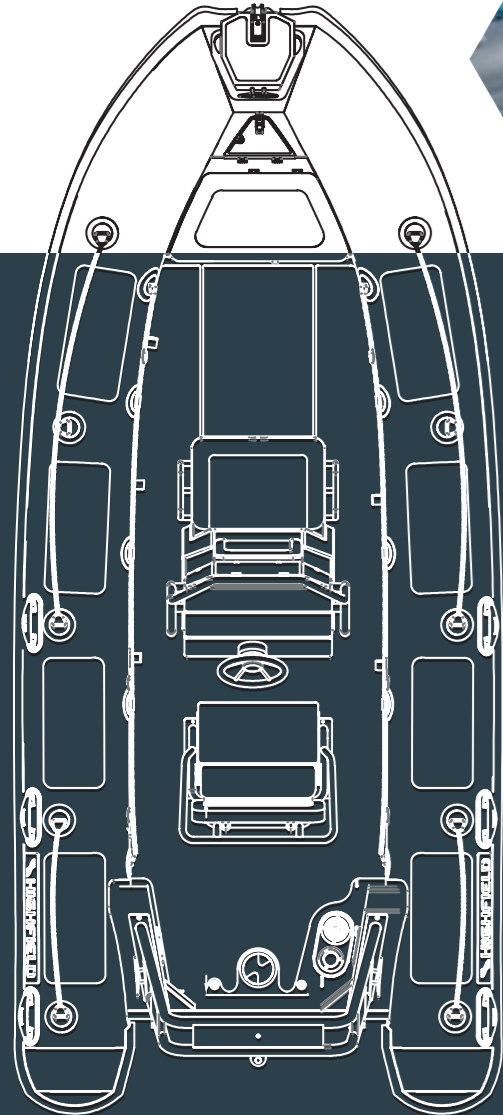

STANDARD FEATURES

- ORCA® Hypalon or PVC tube
- Welded seams (PVC)
- Flush mount non-return valves
- High tensile chromated & powder coated aluminum hull
- Integrated transom supports
- Self-draining deck
- Steering wheel
- Integrated under-deck fuel tank
- Lifting points and towing eyes
- Tow bridle points
- Anti-slip deck
- Heavy duty rubbing strake
- Keel guard
- Highfield dry bag
- Foot pump, oars, repair kit
- Carbon dash
- Electrical pack for console
- Electrical pack for boat
- Transom ladder
- Bow cushion

OPTIONAL EXTRAS

- Console & seat options
- Rear tow post - Roll Bar
- Suspension seat with shock
- Dive rack

A LARGER CONSOLE & A CHOICE BETWEEN BOLSTER OR JOCKEY SEATS. 100HP OF POWER MAKES THIS THE PERFECT SMALL WORKHORSE.

OVERALL LENGTH	500cm	16'5"
INTERNAL LENGTH	416cm	13'8"
OVERALL WIDTH	228cm	7'6"
INTERNAL WIDTH	120cm	3'11"
DEADRISE	24°	
TUBE DIAMETER	52cm	20"
NUMBER OF AIR CHAMBERS	6	
MAXIMUM LOAD	1135kg	2502lbs
MAXIMUM PEOPLE	10	
BOAT WEIGHT*	441 kg	972lbs
MAXIMUM POWER	100hp	
ENGINE SHAFT	L	
FUEL TANK	90l	
DESIGN CATEGORY	C	

* boat, console, standard seating & roll-bar only



PATROL 540

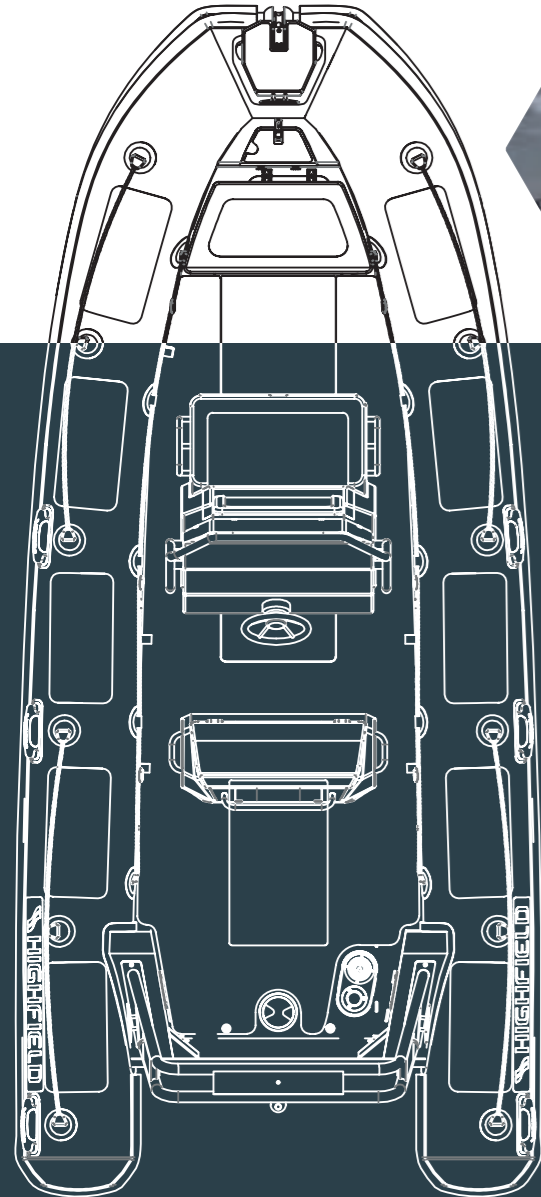

STANDARD FEATURES

- ORCA® Hypalon or PVC tube
- Welded seams (PVC)
- Flush mount non-return valves
- High tensile chromated & powder coated aluminum hull
- Integrated transom supports
- Self-draining deck
- Steering wheel
- Integrated under-deck fuel tank
- Lifting points and towing eyes
- Tow bridle points
- Anti-slip deck
- Heavy duty rubbing strake
- Keel guard
- Highfield dry bag
- Foot pump, oars, repair kit
- Carbon dash
- Electrical pack for console
- Electrical pack for boat
- Transom ladder - Bow cushion

OPTIONAL EXTRAS

- Console & seat options
- Roll Bar - T-Top
- Suspension seat with shock
- Dive rack

AN INCREDIBLY CAPABLE RIB, IDEAL FOR BOTH FAMILY DISTANCE CRUISING OR COMMERCIAL USE INCLUDING TEACHING, CHARTER AND HARBOUR WORK. THE PATROL 600 REALLY IS A PERFECT ALL-ROUNDER - QUICK, DRY AND ECONOMICAL.

OVERALL LENGTH	540cm	17'9"
INTERNAL LENGTH	430cm	14'1"
OVERALL WIDTH	248cm	8'2"
INTERNAL WIDTH	133cm	4'4"
DEADRISE	24°	
TUBE DIAMETER	52cm	20"
NUMBER OF AIR CHAMBERS	6	
MAXIMUM LOAD	1375kg	3031lbs
MAXIMUM PEOPLE	12	
BOAT WEIGHT*	574kg	1264lbs
MAXIMUM POWER	115hp	
ENGINE SHAFT	XL	
FUEL TANK	105l	
DESIGN CATEGORY	C	

* boat, console, standard seating & roll-bar only

PATROL 600

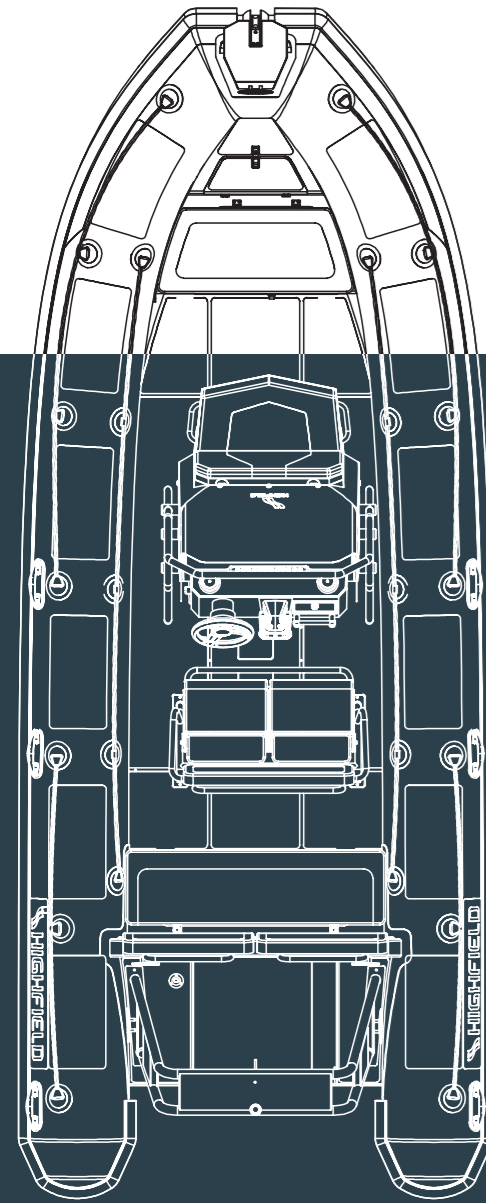

STANDARD FEATURES

- ORCA® Hypalon or PVC tube
- Welded seams (PVC)
- Flush mount non-return valves
- High tensile chromated & powder coated aluminum hull
- Integrated transom supports
- Self-draining deck
- Steering wheel
- Integrated under-deck fuel tank
- Lifting points and towing eyes
- Tow bridle points
- Anti-slip deck
- Heavy duty rubbing strake
- Keel guard
- Highfield dry bag
- Foot pump, oars, repair kit
- Carbon dash
- Electrical pack for console
- Electrical pack for boat
- Transom ladder - Bow cushion

OPTIONAL EXTRAS

- Console & seat options
- Roll Bar with ladder - T-Top
- Suspension seat with shock
- Dive rack - Deck wash

AN INCREDIBLY CAPABLE RIB, IDEAL FOR BOTH FAMILY DISTANCE CRUISING OR COMMERCIAL USE INCLUDING TEACHING, CHARTER AND HARBOUR WORK. THE PATROL 600 REALLY IS A PERFECT ALL-ROUNDER - QUICK, DRY AND ECONOMICAL.

OVERALL LENGTH	617cm	20'3"
INTERNAL LENGTH	449cm	14'9"
OVERALL WIDTH	258cm	8'6"
INTERNAL WIDTH	132cm	4'3"
DEADRISE	26°	
TUBE DIAMETER	54cm	21"
NUMBER OF AIR CHAMBERS	6	
MAXIMUM LOAD	1580kg	3483lbs
MAXIMUM PEOPLE	14	
BOAT WEIGHT * *	752kg	1658lbs
MAXIMUM POWER	150hp	
ENGINE SHAFT	XL	
FUEL TANK	140l	
DESIGN CATEGORY	C	

*smaller tube diameter available ** boat, console, roll-bar & standard seating only

PATROL 660

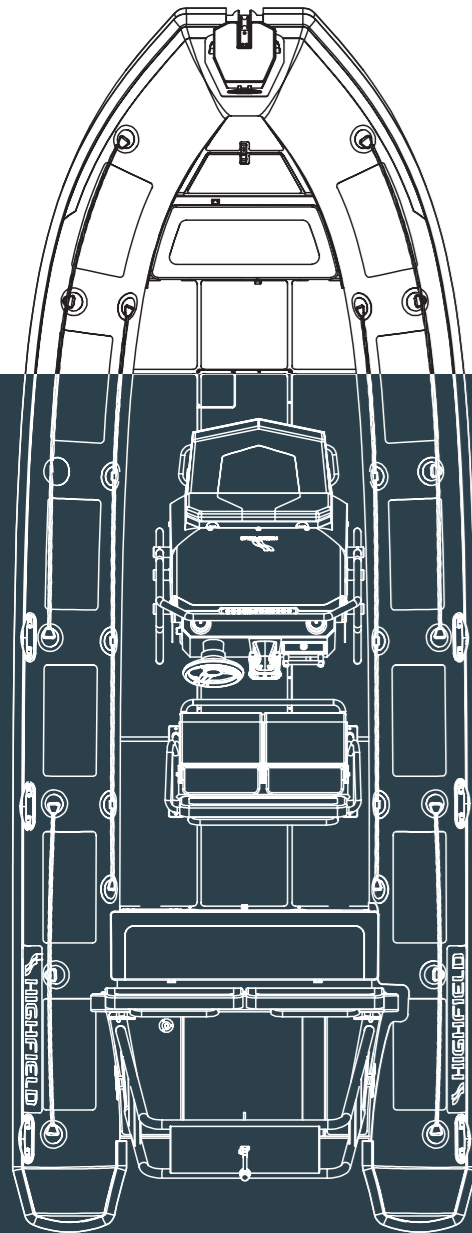

STANDARD FEATURES

- ORCA® Hypalon or PVC tube
- Welded seams (PVC)
- Flush mount non-return valves
- High tensile chromated & powder coated aluminum hull
- Integrated transom supports
- Self-draining deck
- Steering wheel
- Integrated under-deck fuel tank
- Lifting points and towing eyes
- Tow bridle points
- Anti-slip deck
- Heavy duty rubbing strake
- Keel guard
- Highfield dry bag
- Foot pump, oars, repair kit
- Carbon dash
- Electrical pack for console
- Electrical pack for boat
- Transom ladder - Bow cushion

OPTIONAL EXTRAS

- Console & seat options
- Roll Bar with ladder - T-Top
- Suspension seat with shock
- Dive rack - Deck wash

AN OPTIONAL T-TOP ALLOWS THE PATROL MODELS TO BECOME EVEN MORE PRACTICAL BY OFFERING MORE SHELTER AND GREATER PROTECTION FROM THE ELEMENTS, CREATING A TRULY VERSATILE ALL-WEATHER RIB.

OVERALL LENGTH	651cm	21'4"
INTERNAL LENGTH	475cm	15'7"
OVERALL WIDTH	247cm	8'1"
INTERNAL WIDTH	135cm	4'5"
DEADRISE	26°	
TUBE DIAMETER	54cm	21"
NUMBER OF AIR CHAMBERS	6	
MAXIMUM LOAD	1535kg	3384lbs
MAXIMUM PEOPLE	13	
BOAT WEIGHT*	781kg	1721lbs
MAXIMUM POWER	200hp	
ENGINE SHAFT	XL	
FUEL TANK	140l	
DESIGN CATEGORY	C	

* boat, console, standard seating & roll bar only



PATROL 700

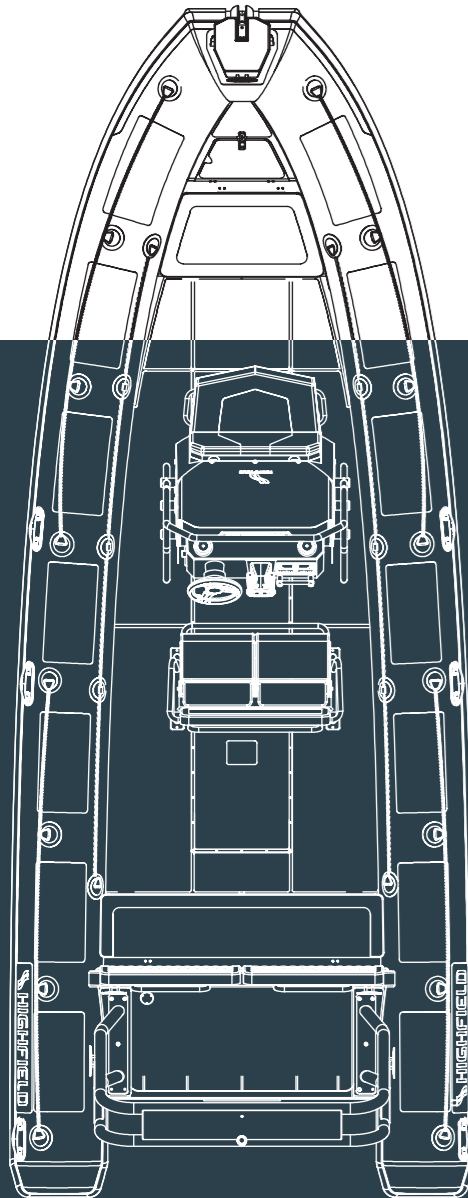

STANDARD FEATURES

- ORCA® Hypalon
- Flush mount non-return valves
- High tensile chromated & powder coated aluminum hull
- Integrated transom supports
- Self-draining deck
- Steering wheel
- Integrated under-deck fuel tank
- Lifting points and towing eyes
- Tow bridle points
- Anti-slip deck
- Heavy duty rubbing strake
- Keel guard
- Highfield dry bag
- Foot pump, oars, repair kit
- Carbon dash
- Electrical pack for console
- Electrical pack for boat
- Transom ladder
- Bow cushion

OPTIONAL EXTRAS

- Console & seat options
- Roll Bar with ladder - T-Top
- Suspension seat with shock
- Dive rack - Deck wash

OUR MID-SIZED WORKHORSE. LONG RANGE FUEL TANK, MODULAR LAYOUT & WIDE BEAM MAKE THE PA700 A GREAT VALUE, CAPABLE ALLROUNDER.

OVERALL LENGTH	699cm	22'11"
INTERNAL LENGTH	523cm	17'2"
OVERALL WIDTH	283cm	9'3"
INTERNAL WIDTH	164cm	5'5"
DEADRISE	26°	
TUBE DIAMETER	54cm	21"
NUMBER OF AIR CHAMBERS	6	
MAXIMUM LOAD	1630kg	3594lbs
MAXIMUM PEOPLE	14	
BOAT WEIGHT*	958kg	2111lbs
MAXIMUM POWER	250hp	
ENGINE SHAFT	XL	
FUEL TANK	285l	
DESIGN CATEGORY	C	

* boat, console, standard seating & roll bar only



PATROL 760

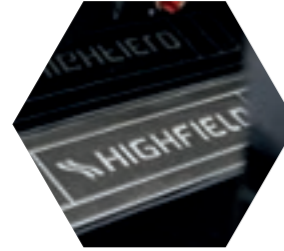
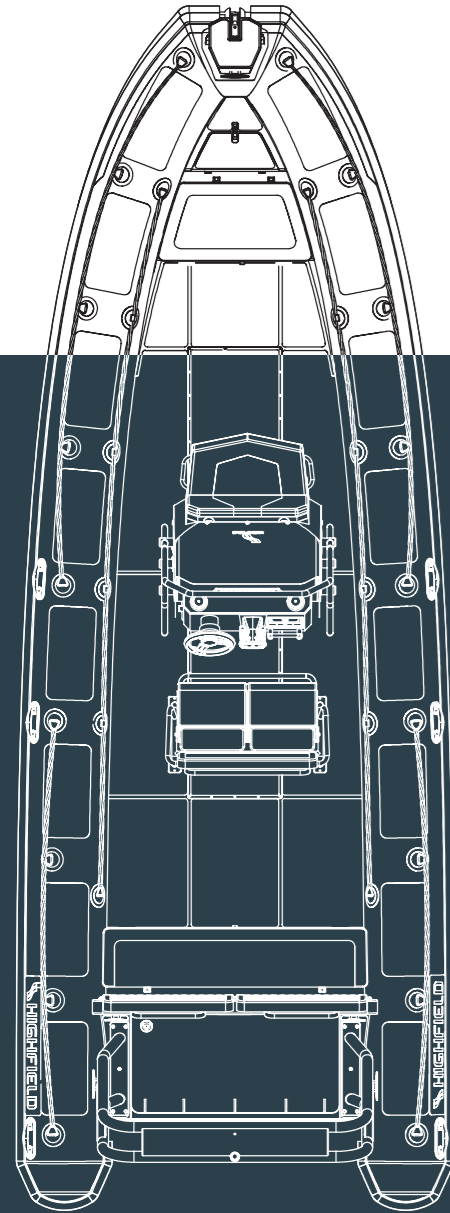

STANDARD FEATURES

- ORCA® Hypalon
- Flush mount non-return valves
- High tensile chromated & powder coated aluminum hull
- Integrated transom supports
- Self-draining deck
- Steering wheel
- Integrated under-deck fuel tank
- Lifting points and towing eyes
- Tow bridle points
- Anti-slip deck
- Heavy duty rubbing strake
- Keel guard
- Highfield dry bag
- Foot pump, oars, repair kit
- Carbon dash
- Electrical pack for console
- Electrical pack for boat
- Transom ladder
- Bow cushion

OPTIONAL EXTRAS

- Console & seat options
- Roll Bar with ladder
- T-Top
- Suspension seat with shock
- Dive rack - Deck wash

**POWERFUL, LONG-RANGE CRUISER
ABLE TO COPE WITH THE MOST
CHALLENGING CONDITIONS. MODULAR
DESIGN FOR ANY SITUATION.**

OVERALL LENGTH	764cm	25'1"
INTERNAL LENGTH	583cm	19'1"
OVERALL WIDTH	281cm	9'3"
INTERNAL WIDTH	165cm	5'5"
DEADRISE	26°	
TUBE DIAMETER	54cm	21"
NUMBER OF AIR CHAMBERS	6	
MAXIMUM LOAD	1820kg	4012lbs
MAXIMUM PEOPLE	12	
BOAT WEIGHT*	1020kg	2249lbs
MAXIMUM POWER	300hp	
ENGINE SHAFT	XL	
FUEL TANK	285l	
DESIGN CATEGORY	C or B	

* boat, console, standard seating, & roll-bar only



PATROL 860

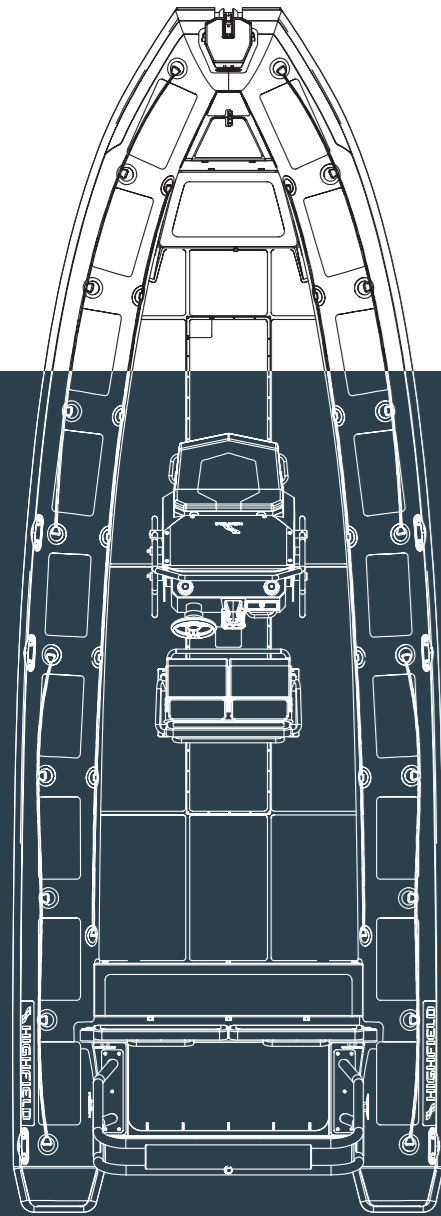

STANDARD FEATURES

- ORCA® Hypalon
- Flush mount non-return valves
- High tensile chromated & powder coated aluminum hull
- Integrated transom supports
- Steering wheel
- Self-draining deck
- Integrated under-deck fuel tank
- Lifting points and towing eyes
- Tow bridle points
- Anti-slip deck
- Heavy duty rubbing strake
- Keel guard
- Highfield dry bag
- Foot pump, oars, repair kit
- Carbon dash
- Electrical pack for console
- Electrical pack for boat
- Transom ladder
- Bow cushion

OPTIONAL EXTRAS

- Console & seat options
- Roll Bar with ladder
- T-Top
- Suspension seat with shock
- Dive rack - Deck wash

LONG RANGE TANKS AND A MODULAR DESIGN ALLOW THE PA860 TO BE BUILT FOR PERFORMANCE, FAMILY BOATING OR A NUMBER OF COMMERCIAL REQUIREMENTS.

OVERALL LENGTH	870cm	28'6"
INTERNAL LENGTH	631cm	20'8"
OVERALL WIDTH	310cm	10'2"
INTERNAL WIDTH	184cm	6'
DEADRISE	26°	
TUBE DIAMETER	58cm	23"
NUMBER OF AIR CHAMBERS	6	
MAXIMUM LOAD	2500kg	5512lbs
MAXIMUM PEOPLE	20	
BOAT WEIGHT*	1156kg	2549lbs
MAXIMUM POWER	2 x 300hp	
ENGINE SHAFT	UL	
FUEL TANK	430l	
DESIGN CATEGORY	B	

* boat, console, standard seating, & roll-bar only



Terms & Conditions: These specification details do not apply to any particular product which is supplied or offered for sale. The manufacturer reserve the right to vary their specification, including colours, with or without notice at such times in such manner as they think fit. Major as well as minor changes may be involved. Every effort, however, is made to ensure the accuracy of the particulars contained in this brochure. Consult the Dealer with whom your order is placed for details of the specification of any particular product. This publication shall not constitute in any circumstances whatsoever an offer by the Company to any person. All sales are made by the Distributor or Dealer concerned subject to and with the benefit of the standard Conditions of Sale and Warranty given by the Distributor or Dealer, copies of which may be obtained from him on request.

DEALER INFORMATION

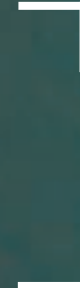
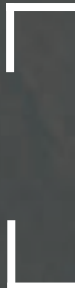

**PLEASE DON'T
BIN ME! RECYCLE
OR PASS ME ON
TO A FRIEND.**